



Instruction Manual – PDF www.sunnexproducts.com www.sunnex1929.com

Deluxe Dry Heat Precision Temperature Control Electric Chafers

W21-11/W21-23/W21-36

(Take W21-11027 for illustration in this instruction manual)

- Main Body of Chafer
- Cover of Chafer
- Food Pan
- Power Cable
- Water Collection Box
- Instruction Manual
- Warranty Card

Warning

Innovative products, do not add water!!

This product is not recommended for use on food with low water content, such as rice, steamed stuffed bun, etc!

Warning

1. The unit may be hot when it is working or has just been powered off. Please handle with care.
2. Before using or cleaning this unit, please read and understand this manual.
3. This unit is only for keeping warm, not cooking. Food should be cooked before it is put into the unit. Do not use the unit other than its intended use.
4. Do not immerse the Stand, Cover and Heating Element in water.
5. This unit is designed without water pan. Do not add water into the chafer except food pan.
6. The following actions may result in burning or scalding: Filling the food pan with hot food beyond its stated capacity. Tilting or dropping the unit when it contains hot food.
7. Never put the unit on unstable surface, only put on flat surface.
8. Before cleaning, switch off and unplug the unit. The area surrounding the heating element will remain hot after the unit has been used and switched off, do not clean the unit until it has fully cooled down.
9. Product Disposal: Dispose in accordance with any local and national disposal regulations relating to the reuse, recovery and recycling of waste electrical and electronic equipment (WEEE).
10. Children should be supervised to ensure that they do not play with the appliance.
11. This appliance is not intended for use by persons (including children) with reduced physical, sensory or mental capabilities, or lack of experience and knowledge, unless they have been given supervision or instruction concerning use of the appliance by a person responsible for their safety.
12. This appliance must be earthed and is for indoor use only. Do not connect it with shared sockets.

Product Specification

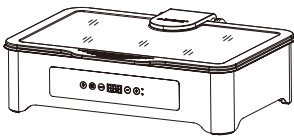

Item No.	W21-11027	Product Name	1/1 Deluxe Dry Heat Precision Temperature Control Electric Chafers (Mirror Finished)
Shape / Cap	Rectangular 1/1, 8.5ltr		
Size with cover closed	595 (L) x 455 (W) x 175 (H) mm		
Size with cover opened	595 (L) x 455 (W) x 575 (H) mm		
Voltage	220V AC, 50/60Hz		
Power Consumption	300W		

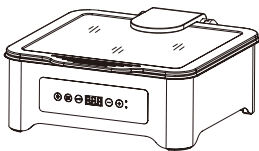

Item No.	W21-23027	Product Name	2/3 Deluxe Dry Heat Precision Temperature Control Electric Chafers (Mirror Finished)
Shape / Cap	Rectangular 2/3, 5.5ltr		
Size with cover closed	420 (L) x 455 (W) x 175 (H) mm		
Size with cover opened	420 (L) x 455 (W) x 575 (H) mm		
Voltage	220V AC, 50/60Hz		
Power Consumption	300W		

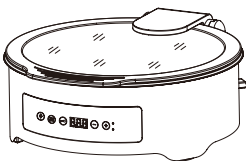

Item No.	W21-36027	Product Name	Round Deluxe Dry Heat Precision Temperature Control Electric Chafers (Mirror Finished)
Shape / Cap	Round, 6.8ltr		
Size with cover closed	460 (L) x 530 (W) x 185 (H) mm		
Size with cover opened	460 (L) x 530 (W) x 665 (H) mm		
Voltage	220V AC, 50/60Hz		
Power Consumption	300W		

Structure & Control Panel

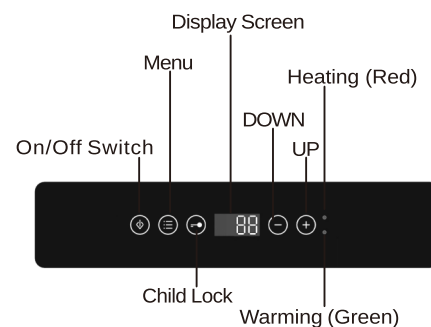
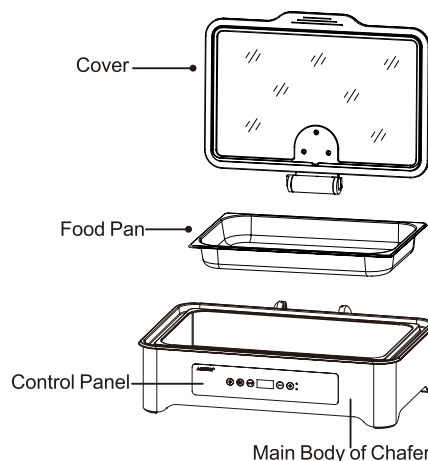
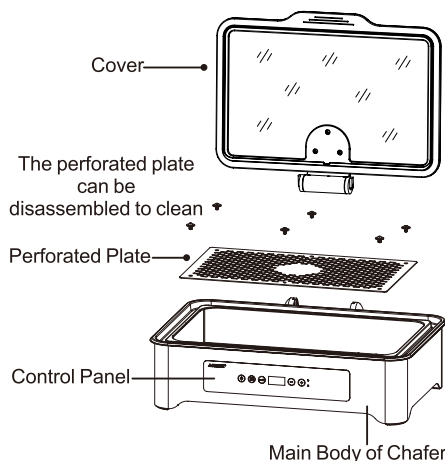

Operation

1. Turn on / Off Chafer



- Connect the chafer to the power supply.
- Connect the rectangular plug to the chafer and then connect the round plug to the chafer. As the connection between the round plug and the chafer is concavo-convex, make sure they are connected with the right positions and twist the round plastic screwcap tight (Diagram 3).
- Touch the On/Off Switch “” to turn on the chafer.
- For turning off the chafer, simply touch the On/Off Switch.

Remark 1 : The connection between the round head cord and the chafer is concavo-convex. Make sure they are connected with right position.

Remark 2 : The power supply should be consistent with the voltage and the power consumption of the chafer.

2. Temperature Setting

Long press the Child lock “” for 3 seconds, the Temperature Display “” flashes and the chafer is ready for setting. Touch Up “” or Down

“” to adjust temperature. After the temperature is set, press the Child Lock “” and the chafer is in operation status. At this moment, the chafer displays the actual temperature surrounding the food pan. If no further adjustment is needed, the chafer will be locked in 5 seconds automatically. If further temperature adjustment is needed, press the Child Lock “”

Kind Reminder : The chafer has three preset temperature: 54°C、76°C、88°C.

In setting status, touch Menu “” to select the preset temperature. The temperature adjustment of the chafer is 40~90°C.

3. Water Collection Box

A water collection box is installed at the back of the chafer. Pour out the water after using. (Diagram 2) Suggest to clean the box at least one time per day to keep hygienic and avoid odor.

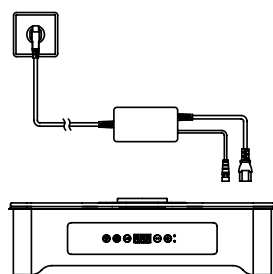

Diagram 1

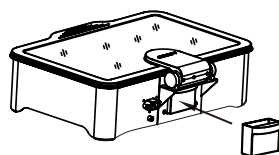

Diagram 2

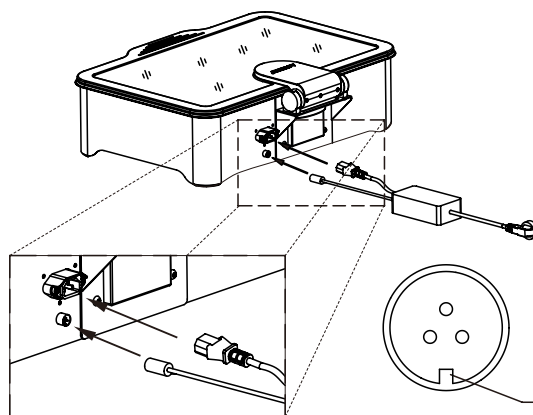

Diagram 3

How to Clean

1. Before cleaning, switch off and unplug the unit. Make sure it is completely cooled down before proceeding.
2. Open the Cover and take out the Food Pan, wash them with a damp cloth with mild detergent. Rinse thoroughly with clean water. Dry them completely before assembling the unit.
3. For the outer surface of the Stand, wipe it over with a damp cloth with mild detergent.

FAQ

Q1、Chafer cannot heat

A1: Check if the unit is plugged and power connected.
A2: If heater or wiring is out of order, pls contact SUNNEX local distributor.

Q2、E01 shown on display screen

A1: If sensor may not work correctly, pls contact SUNNEX local distributor.

Q3、Add water into chafer by mistake

A1: Do not use the chafer until the water become dry completely.

Q4、The mesh plate is deformed slightly during heating

A1: It is because of heat expansion and cold contraction. It will recover after cooling.

Q5、The mesh plate will become yellow after using for a period of time

A1: Stainless steel occurs oxidation under high temperature environment. It is normal phenomenon.

Q6、The chafer has one or two abnormal sounds at the beginning of heating

A1: It is because of heat expansion and cold contraction. The sounds will disappear after heating up. The perforated plate is removable and washable for cleaning by user.

Q7、The soup flows into the mesh plate carelessly

A1: Use dry dishcloth to clean if there is only little soup.

A2: Need to disassemble the chafer for cleaning if a lot of soup flows into the mesh plate. Contact SUNNEX local distributor for help.

Contact Information

Market	Phone	Website	Email
Outside China	+852-2775-0204 +86-775-2555-4136	www.sunnexproducts.com www.sunnex1929.com	sales@sunnexproducts.com sales@sunnex1929.com
Within China	+86-755-2555-1571 / +86-18922042156 (After-sales hotline)	www.sunnexchina.com	sales@sunnexchina.com